



TO.GO

Happy

IRI.TX



BENINCA[®]
TECHNOLOGY TO OPEN

TO.GO 2A TO.GO 2VA TO.GO 2AS TO.GO 2AK TO.GO 4ASE TO.GO 2QV HAPPY 2VA HAPPY 2AK IRI.TX4VA IRI.TX4AK
TO.GO 4A TO.GO 4VA TO.GO 4AS TO.GO 4AK HAPPY 4VA HAPPY 4AK

PROGRAMMING GUIDE

INDEX

ADVANCED ROLLING-CODE (ARC) 128 BIT	3
TECHNICAL SPECIFICATIONS.....	3
IRI.TX - MODELS AND SPECIFICATIONS	3
HAPPY - MODELS AND SPECIFICATIONS.....	4
TO.GO - MODELS AND SPECIFICATIONS	4
THE RECEIVERS	5
EEPROM	5
STORING OF TRANSMITTERS	6
BOX RECEIVER (ONE.2WB/ONE.2WO AND EARLIER VERSIONS)	6
PLUG-IN RECEIVER (ONE. 2WI AND EARLIER VERSIONS)	6
CONTROL UNITS WITH BUILT-IN RADIO AND LEARNING BUTTON	7
CONTROL UNITS WITH BUILT-IN RADIO CONTROL AND LCD DISPLAY.....	7
ADVANCED FUNCTIONS.....	8
SELECTION OF THE TYPE OF ENCODING (TO. GO/HAPPY VA)	8
SELECTION OF THE TYPE OF ENCODING (IRI.TX)	8
HIDDEN BUTTON ACTIVATION.....	8
REMOTE LEARNING.....	9
TRANSMITTER CLONING	10
ADDITIONAL CHANNELS.....	11
BATTERY REPLACEMENT	12
TO.GO.....	12
HAPPY	12
IRI.TX.....	12
INSTRUCTIONS FOR DISPOSAL	13

> ADVANCED ROLLING-CODE (ARC) 128 BIT

The introduction of the new rolling-code encoding at 128 bit ARC brings the safety of Benincà radio system to a higher level. ARC logo affixed to product packaging ensures compatibility of the receiver to the new standard:



The memorization of new ARC transmitters is very similar to that of normal Rolling Code transmitters with HCS* code, but you should note the following:

ARC and HCS Rolling Code transmitters cannot be saved on the same receiver simultaneously, since the two types of encoding are not compatible with each other.

The first transmitter saved determines the type of transmitters to use later.

If the first transmitter saved is the ARC, you will not be able to save HCS Rolling Code transmitters, and vice versa.

Fixe-code transmitters may only be used in combination with HCS Rolling Code transmitters, bringing the logic (or the dip/switch) CVAR to OFF. Therefore, they cannot be used in conjunction with ARC transmitters. If the first Rolling Code transmitter stored is an ARC, the CVAR logic has no effect. If you want to change the type of transmitter you must a reset the receiver (as shown in the user's manual of the device).

* HCS Rolling-Code transmitters are traditional Benincà Rolling Code transmitters normally used prior to the introduction of the ARC encoding.



IMPORTANT! Some products can exclusively use the new ARC transmitters and do not allow use of HCS or fixed code transmitters. These items are marked with the "ARC Only" sticker.

> TECHNICAL SPECIFICATIONS

	IRI.TX 4VA	IRI.TX 4AK	HAPPY 2AK HAPPY 4AK	HAPPY 2VA HAPPY 4VA	TO.GO 2A TO.GO 4A	TO.GO 2VA TO.GO 4VA	TO.GO 2AK TO.GO 4AK	TO.GO 2AS TO.GO 4AS	TO.GO 4QV
Power supply	A23 type 12V alkaline battery								
Battery life	2 years with 10 transmissions per day								
Radio encoding	Rolling code 128bit ARC and rolling code 64bit HCS	Rolling code 128bit ARC or fixed code	Rolling code 128bit ARC or fixed code	Rolling code 128bit ARC and rolling code 64bit HCS	Rolling code 128bit ARC	Rolling code 128bit ARC and rolling code 64bit HCS	Rolling code 128bit ARC or fixed code	Rolling code 128bit ARC	Rolling code 64bit HCS
Transmission frequency	433,92 Mhz								868 Mhz
Operating temperature	(-0 +50) °C								
Capacity	230 m in open air without interference								
Protection rating	IP40								
Size	68x40x15 mm		68x41x15 mm			65x40x14 mm			

> IRI.TX - MODELS AND SPECIFICATIONS



IRI.TX 4VA

Rolling code transmitter 433.92 MHz with 2 or 4 channels with ARC or HCS encoding (settable). The factory setting is ARC code that can be used with both types of Rolling-code receivers made by Benincà.



IRI.TX 4AK

ARC Rolling code transmitter 433.92 MHz with 2 or 4 channels. Cloneable version that allows for creating a duplicate of a ARC or Fixed Code transmitter already stored or can be used as a normal ARC encoded transmitter.

> HAPPY - MODELS AND SPECIFICATIONS



HAPPY 2VA - HAPPY 4VA

Rolling code transmitter 433.92 MHz with 2 or 4 channels with ARC or HCS encoding (settable). The factory setting is ARC code that can be used with both types of Rolling-code receivers made by Benincà.



HAPPY 2AK - HAPPY 4AK

ARC Rolling code transmitter 433.92 MHz with 2 or 4 channels. Cloneable version that allows for creating a duplicate of a Fixed Code transmitter already stored or can be used as a normal ARC encoded transmitter.

> TO.GO - MODELS AND SPECIFICATIONS



TO.GO 2A - TO.GO 4A

Rolling code transmitter 433.92 MHz with 2 or 4 channels with ARC encoding to use only with the new compatible ARC receivers.



TO.GO 2VA - TO.GO 4VA

Rolling code transmitter 433.92 MHz with 2 or 4 channels with ARC or HCS encoding (settable). The factory setting is ARC code that can be used with both types of Rolling-code receivers made by Benincà.



TO.GO 2AS - TO.GO 4AS

Transmitter 433.92 MHz with 2 or 4 channels and ARC rolling code supplied in packages with consecutive serial number. The package bears the initial and final serial numbers to use with the Advantouch programmer for storing a high number of transmitters by a single operation.



TO.GO 2AK - TO.GO 4AK

ARC Rolling code transmitter 433.92 MHz with 2 or 4 channels. Cloneable version that allows for creating a duplicate of a Fixed Code transmitter already stored or can be used as a normal ARC encoded transmitter.



TO.GO 4QV

Rolling code transmitter 868MHz with 4 channels with HCS encoding.

> THE RECEIVERS

The receivers compatible with the new TO.GO/HAPPY ARC transmitters are available in 4 versions:



External box receiver to apply to the inside of the controller container, if the controller is not provided with built-in receiver.

This type of receiver has a terminal board for the connection of the power supply, the radio antenna and two settable outputs. Being a 100% independent device, it can be used for any application requiring a radio control.

In this guide we will refer to the model ONE2WB (article code 9673103), a two-channel receiver that handles ARC, HCS and fixed codes

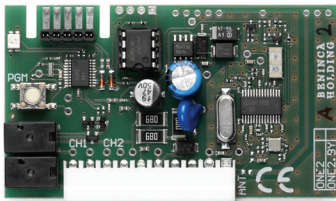

Plug-in receiver for controllers equipped with a quick molex connector.

This type of receiver, once inserted into the controller connector, works like a built-in receiver, receiving power and antenna signal from the controller, while the switch channels are handled by the controller. Programming is carried out using the button and the LED indicator on the receiver.

In this guide we will refer to the model ONE2WI (article code 9673102), a two-channel receiver that handles ARC, HCS and fixed codes

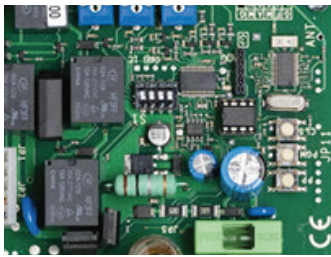

Built-in receiver, integrated into the controller, programmable via dip-switches/trimmers.

This type of controller features a programming button and a LED indicator that allows the user to set up the functions of the integrated receiver.

In this guide we will refer to the model CPJ3, the controller incorporated in the geared motors JM.3, the procedure is also similar to that of other controllers equipped with integrated receiver.

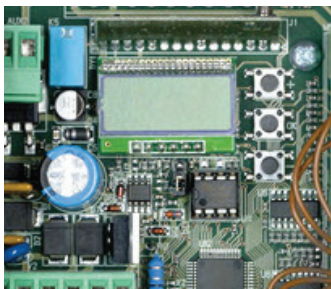

Built-in receiver, integrated into the controller, programmable via LCD display.

This type of controllers always has a radio menu through which you can perform all the operations for programming the integrated receiver. The radio menu also allows for the management of advanced features of each device.

In this guide we will refer to the model BRAINY, the procedure is, once again, similar to that of other controllers with LCD display

> EEPROM

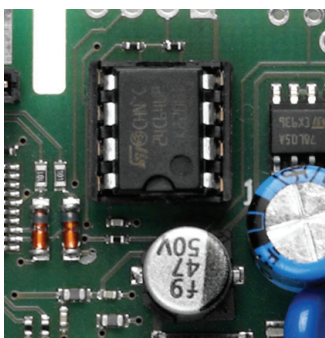

It is important to know that most Benincà receivers store transmitter codes in a special removable memory (EEPROM).

The picture to the side shows an EEPROM installed on a controller, in the instructions included with the device always show the position of the EEPROM.

Should you need to replace a controller or a receiver, you can remove the EEPROM from the old card and install it on the new one (as long as the devices are of the same model).

This will prevent having to store again all the transmitters, a very useful feature especially if a receiver is used by many users (condominiums, residences, communities).

There is also a special high-capacity EEPROM available (art. MEM 2048) able to store a large number of transmitters (2048) compared to standard EEPROM (that can store usually only 64 codes).

> STORING OF TRANSMITTERS

> BOX RECEIVER (ONE.2WB/ONE.2WO AND EARLIER VERSIONS)

Connect the antenna to the appropriate input using only RG58 cable, then power the device according to the instructions given in the user's manual.

The box receivers usually feature two transmission channels (CH1 and CH2), to identify the channel on which you are performing the programming, the LED color is used:

The channel CH 1 is associated with the color RED

The channel CH 2 is associated with the color GREEN

To store a transmitter in the memory proceed as follows:

- Press the Program button, using a paper clip until the red LED lights up.
- Within 5 seconds, press the button of the transmitter to be associated with the channel 1.
- Within the following 5 seconds, you can save a new transmitter to channel 1.
- To associate the channel 2, press 2 times the Program button of the device until the green LED lights up.
- Within 5 seconds, press the button of the transmitter to be associated with the channel 2.
- Within the following 5 seconds, you can save a new transmitter to channel 2.

The box receivers also allow for setting of other functions such as setting a switching time or the output switching mode (mono-stable/bistable). For more information refer to the instructions supplied with the device.

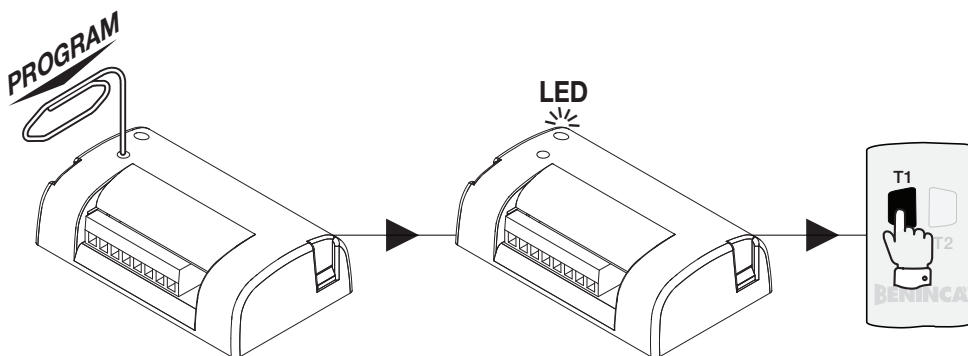

> PLUG-IN RECEIVER (ONE. 2WI AND EARLIER VERSIONS)

Insert the plug-in receiver in the moxex connector in the control unit.

The moxex connector has a dedicated plug-in side that must be observed.

The control unit must be powered, the antenna must be connected to the relevant terminals using exclusively an RG58 cable.

The plug-in receivers usually feature two transmission channels (CH1 and CH2), to identify the channel on which you are performing the programming, the LED color is used:

The channel CH 1 is associated with the color RED

The channel CH 2 is associated with the color GREEN

To store a transmitter in the memory proceed as follows:

- Press the Program button, until the red LED lights up.
- Within 5 seconds, press the button of the transmitter to be associated with the channel 1.
- Within the following 5 seconds, you can save a new transmitter to channel 1.
- To associate the channel 2, press 2 times the Program button of the device until the green LED lights up.
- Within 5 seconds, press the button of the transmitter to be associated with the channel 2.
- Within the following 5 seconds, you can save a new transmitter to channel 2.

The plug-in receivers also allow for setting of other functions such as setting a switching time or the output switching mode (mono-stable/bistable). For more information refer to the instructions supplied with the device.

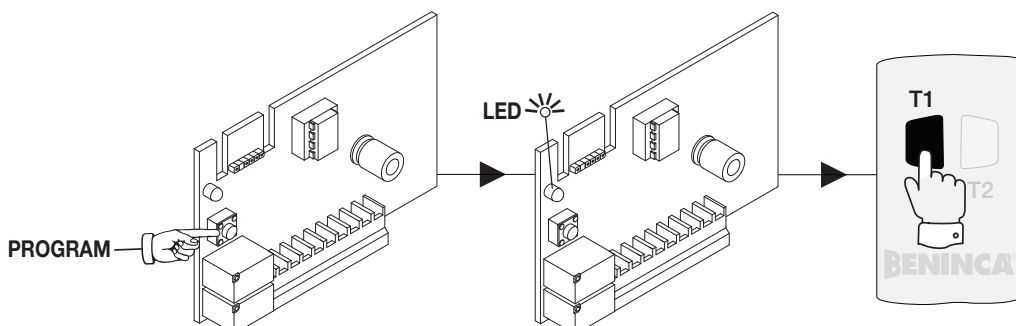

➤ CONTROL UNITS WITH BUILT-IN RADIO AND LEARNING BUTTON

This type of controller features a programming button and a LED indicator that allows the user to set up the functions of the integrated receiver.

The control unit must be powered, the antenna must be connected to the relevant inputs using exclusively an RG58 cable.

The name of the button and that of the LED vary depending on the controller. In the example below, we refer to a CP.J3 controller:

- Press 1 time the PGM button for 1s, LED DL1 starts blinking with a pause of 1s to indicate, to show that the receiver is waiting for a transmitter code.
- Press within 10s the button of the transmitter to be memorised with the P.P. function. After storing the transmitter, the receiver automatically exits the programming phase.
- Within 10s from saving, you can save other transmitters.
- Some controllers use the LED or the assistive light to confirm that the transmitter has been saved successfully.
- To exit the programming mode without saving any transmitter, wait 10s.

Some control units may feature special functions (pedestrian opening, second radio channel). Consult the device's instructions for more information.

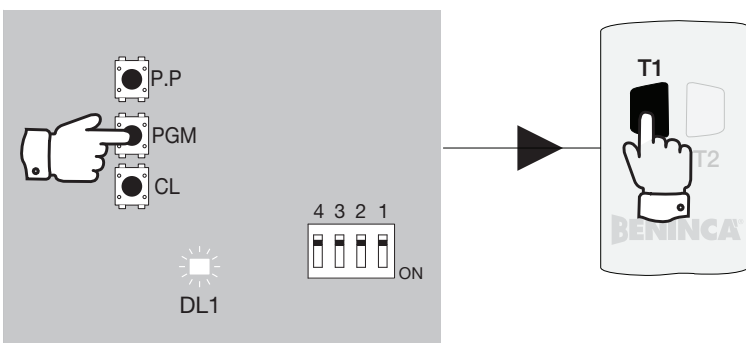

➤ CONTROL UNITS WITH BUILT-IN RADIO CONTROL AND LCD DISPLAY

This type of controllers have a radio menu through which you can perform all the operations for programming the integrated receiver.

The control unit must be powered, the antenna must be connected to the relevant inputs using exclusively an RG58 cable.

Press the button <OK>, the LCD display switches on and opens the first menu available (usually "Parameters" PAR).

- Use the button <+> or <-> to navigate in the menu "RADI" (RADIO).
- Press the button <OK>, the display shows the first function available in the menu (usually the function PP).
- Select with the button <+> or <-> the "PP" function.
- Press the button <OK>, the display shows the message "PUSH" to indicate that a button is waiting and prompts you to push the button of the transmitter that you want to associate.
- Upon completion, "OK" will appear on the display.

The radio menu also has other functions specific to the type of controller (pedestrian opening, second radio channel, separate open/close); refer to the instructions included with the device

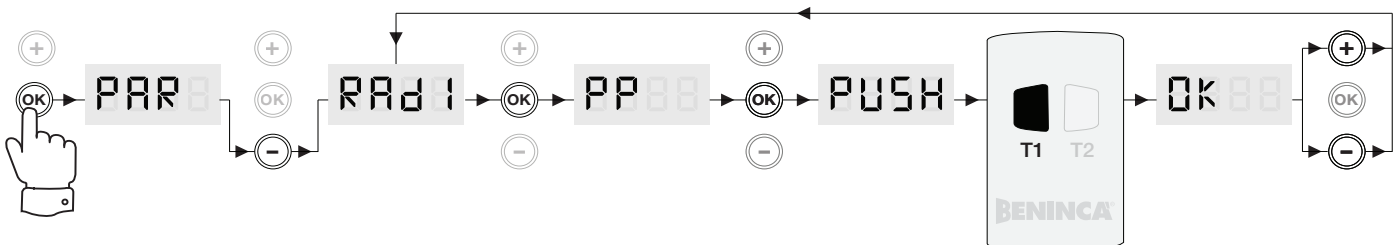

> ADVANCED FUNCTIONS

> SELECTION OF THE TYPE OF ENCODING (TO. GO/HAPPY VA)

VA series transmitters can operate in either HCS (Benincà Rolling-code) or ARC (Advanced Rolling-code) mode. This allows you to use the transmitters on systems equipped with HCS receivers. The transmitter comes with ARC mode factory setting.

To modify the code type:

- Press and keep simultaneously pressed keys T1 and T2.
- After approx. 3 seconds, the LED starts to flash, the number of flashes indicates the code currently set:
 - 3 flashes and pause of 1 second, the transmitter is to be set up as ARC.
 - 4 flashes and pause of 1 second, the transmitter is to be set up as ARC + HCS*.
 - 2 flashes and pause of 1 second, the transmitter is to be set up as HCS.
- Keeping buttons T1-T2 pressed, after approx. 20 seconds, the LED switches on fixed for approx. 3s. Releasing the buttons during these 3s, the transmitter is configured with the net operating mode (mode 3 blink >> 4 blink >> 2 blink >> 3 blink >> 4 blink >> etc).

 If buttons T1/T2 are released when the LED is not on with the light fixed, no configuration change is made.

**In this mode, the keys on the left (T1 and T3) are coded ARC and those on the right (T2 and T4) are coded HCS. This mode is only available for transmitters marked "128".*

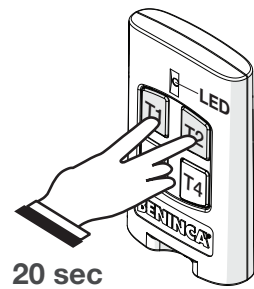

20 sec

> SELECTION OF THE TYPE OF ENCODING (IRI.TX VA)

VA series transmitters can operate in either HCS (Benincà Rolling-code) or ARC (Advanced Rolling-code) mode. This allows you to use the transmitters on systems equipped with HCS receivers. The transmitter comes with ARC mode factory setting.

To modify the code type:

- Press and keep simultaneously pressed keys T1 and T2.
- After approx. 3 seconds, the LED starts to flash, the number of flashes indicates the code currently set:
 - 3 flashes and pause of 1 second, the transmitter is to be set up as ARC.
 - 4 flashes and pause of 1 second, the transmitter is to be set up as ARC + HCS*.
 - 2 flashes and pause of 1 second, the transmitter is to be set up as HCS.
- Keeping buttons T1-T2 pressed, after approx. 20 seconds, the LED switches on fixed for approx. 3s. Releasing the buttons during these 3s, the transmitter is configured with the net operating mode (mode 3 blink >> 4 blink >> 2 blink >> 3 blink >> 4 blink >> etc).

 If buttons T1/T2 are released when the LED is not on with the light fixed, no configuration change is made.

**In this mode, the keys T1 and T3 are coded ARC and T2 and T4 are coded HCS.*

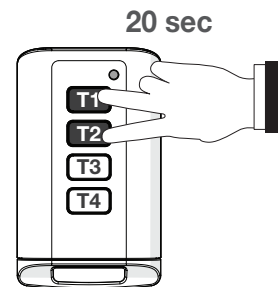

20 sec

> HIDDEN BUTTON ACTIVATION

Some advanced features require pressing the "Hidden Key".

In traditional transmitters, the hidden key is a button inside the container that must be pressed with a paper clip or a piece of wire.

In new transmitters TO.GO/HAPPY/IRI.TX ARC, the "Hidden Key" can be accessed by pressing the keys T1 and T2 simultaneously for at least 3 seconds.

When the LED flashes, it means that the "Hidden Key" code was sent.

Attention: If the LED flashes before 3 seconds, it means that the keys were not pressed simultaneously and you did not send the "Hidden Key" code

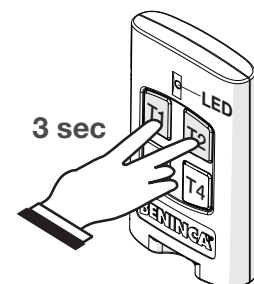

3 sec

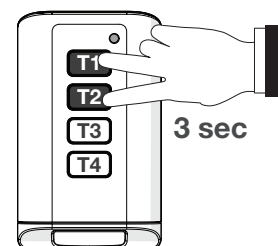

3 sec

➤ REMOTE LEARNING

Remote learning allows you to enter a new transmitter in the receiver if you have a previously memorized transmitter, without having to access the receiver.

Therefore, you will quickly have a new transmitter that resembles the one originally stored.

It is mandatory to **operate within the reception range** of the receiver.

The procedure is different depending on the device used. There are still two possible modes:

Remote Learning In Receivers One WB/WI

Proceed as follows:

- Press the hidden key of the transmitter saved, namely the simultaneous combination of T1 and T2 keys, for 3 seconds (the red LED on the transmitter flashes)
- Press within 5 seconds the key on the previously memorized transmitter corresponding to the channel to associate with the new transmitter.
- Within 5 seconds, press the key of the new transmitter to be associated with the selected channel.
- The receiver exits the programming mode, check the proper operation of the new transmitter saved.

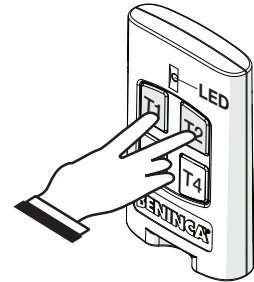

The procedure can be summarized as follows:

- Hidden key of the currently active transmitter (T1 + T2 for 3s)
- Key of the transmitter already operative with the function to duplicate (within 5s)
- Key of the new transmitter (5s)

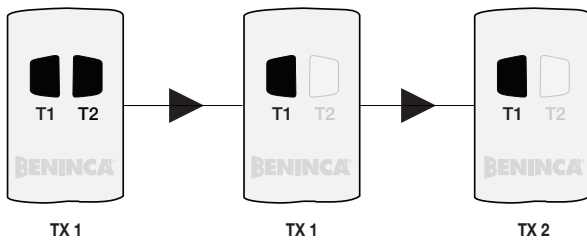

Notes:

Remote learning is only possible with ARC and HCS transmitter, and is not possible with fixed code transmitters.

Remote Learning In Receivers Built Into The Control Units

Proceed as follows:

- Press the hidden key of the transmitter saved (the red LED on the transmitter flashes)
- Press within 5 seconds the key on the previously memorized transmitter corresponding to the channel to associate with the new transmitter.
- Press the hidden key of the transmitter saved (the red LED on the transmitter flashes)
- Within 5 seconds, press the key of the new transmitter to be associated with the selected channel.
- The receiver exits the programming mode, check the proper operation of the new transmitter saved.

The procedure can be summarized as follows:

- Hidden key of the currently active transmitter (T1 + T2 for 3s)
- Key of the transmitter already operative with the function to duplicate (within 5s)
- Hidden key of the new transmitter (T1 + T2 for 3s)
- Key of the new transmitter (5s)

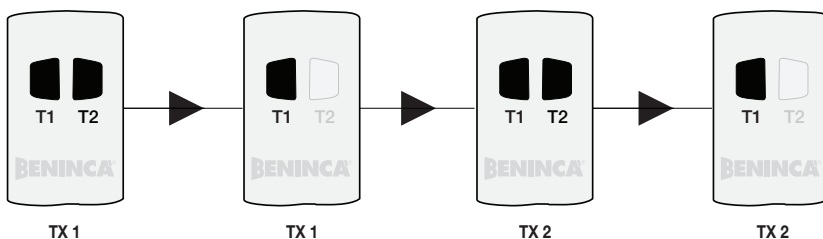

Notes:

Some controllers signal the various learning phases via the assistive or the flashing light.

Remote learning is only possible with ARC and HCS transmitter, and is not possible with fixed code transmitters.

For security reasons, remote learning is prevented during motor opening/closing.

In some cases, the procedure must be performed with the doors fully opened; consult the device's instructions.

> TRANSMITTER CLONING

TO.GO AK / HAPPY AK / IRI.TX AK

Cloning is intended as the ability of the AK series transmitters to be programmed with the same code as an ARC or Fixed Code* transmitter already saved on a receiver, or to replace most fixed-code transmitters on the market with a simple and fast procedure without the need to access the receiver nor to open the remote control.

An important innovation featured by these new AK versions is the implementation of double-encoding, ARC or fixed: this transmitter can be used as a normal cloneable transmitter or as a real ARC transmitter with variable code.

In fact, the AK radio control, if not used to clone a fixed code transmitter, sends the code by default with Advanced Rolling Code encoding.

The only way to make it use the fixed-code is to program it starting from TO.GOWP or TO.GOWK or by other AK series transmitters already programmed with fixed code.

Quick cloning

With quick cloning you get a transmitter that replicates exactly every single channel of the original transmitter (already memorized) in the new transmitter AK; we recommend using a 2AK to clone a two-channel original transmitter and a 4AK to clone a four-channel transmitter.

Proceed as follows:

- 1) press and hold the key T1 of the new transmitter AK. When pressing T1, the LED lights up steadily, after 5 seconds it will begin to flash rapidly, after 15s to flash slowly.
- 2) after about 15s, put the original transmitter near the new transmitter as shown in the picture, and continue to hold the key T1 on the new remote control, and press any button on the original remote control.
- 3) if the procedure was completed successfully, the LED of the new transmitter AK will turn off. Release all the keys pressed. All channels of the original transmitter are replicated on the new AK transmitter.

N.B.: Use for both remote controls batteries charged.

If after 15 sec. the red LED on the new transmitter is not off, release the buttons of the remote control and after 1 minute, repeat from step 1, being careful to place the original transmitter as shown in the picture.

Advanced cloning

In advanced cloning you can choose which channel of the original transmitter (already memorized) will be replicated on the new AK transmitter.

For example, you can replicate channel 3 of an old transmitter on channel 1 of a AK transmitter, which is not possible during quick cloning. Proceed as follows:

- 1) on the new AK, press and hold the key of which you want to replicate the function of the original. When you press the button, the LED lights up steadily, after 5 seconds it will begin to flash rapidly.
- 2) after 5s, put the original transmitter near the new transmitter as shown in the picture, and continue to hold the key on the new remote control, and press the button of the original remote control whose code you intend to copy.
- 3) if the procedure was completed successfully, the LED of the new transmitter AK will turn off. Release all the keys pressed. The channel chosen in the original transmitter is now replicated in the AK transmitter.

N.B.: Use for both remote controls batteries charged.

If after 30 sec. the red LED on the new transmitter is off, release the buttons of the remote control and repeat from step 1, being careful to place the original transmitter as shown in the picture.

* Transmitters with HCS coding cannot be cloned.

ATTENTION!

The positions indicated in the following figures guarantee the best communication among transmitters during the cloning phase.

NEW: New AK transmitter - ORIGINAL: Transmitter already saved.

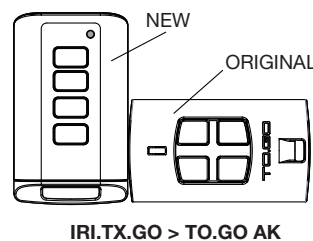
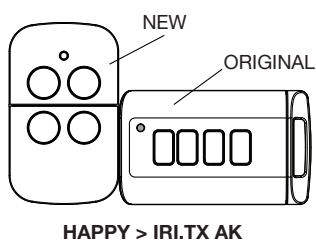
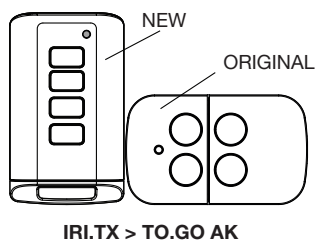
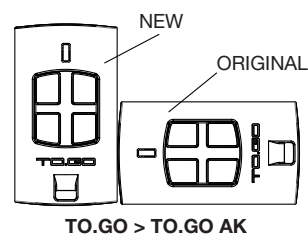
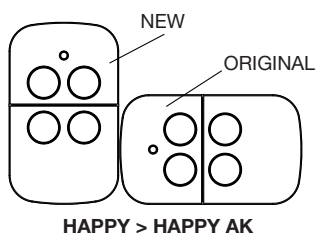
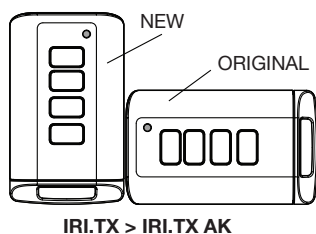

> ADDITIONAL CHANNELS

All the 4-channel ARC transmitters, with the exception of the clonable AK, have a further 5 transmission channels to select by simultaneously pressing two keys. Channels from 5 to 9 are therefore obtained, according to the combination of keys selected. Refer to the diagrams on this page, if necessary you can print the diagram and use it as a memo.

The combination of keys 1+2 is reserved for the hidden key function.

It is important, during the learning phase and during the transmission phase, that the pair of keys are pressed simultaneously, otherwise the transmitter will send the code of the channel pressed first..

IRI.TX



CH1



CH2



CH3



CH4



N/A



CH5



CH6



CH7



CH8



CH9

HAPPY



CH1



CH2



CH3



CH4



N/A



CH5



CH6



CH7



CH8



CH9

TO.GO



CH1



CH2



CH3



CH4



N/A



CH5



CH6



CH7



CH8



CH9

> BATTERY REPLACEMENT

If during normal operation, the LED flashes by pressing any button, the battery is low and needs to be replaced. To replace the battery, open the battery lid using a screwdriver as shown in the picture, by lightly pressing on both slits. Replace the battery following the polarity, the symbol + is indicated in the printed circuit board.

WARNING!:

Batteries are special waste and must be disposed of in compliance with the regulations in force.

TO.GO

To replace the battery, open the battery lid using a screwdriver as shown in the picture, by lightly pressing on both slits.

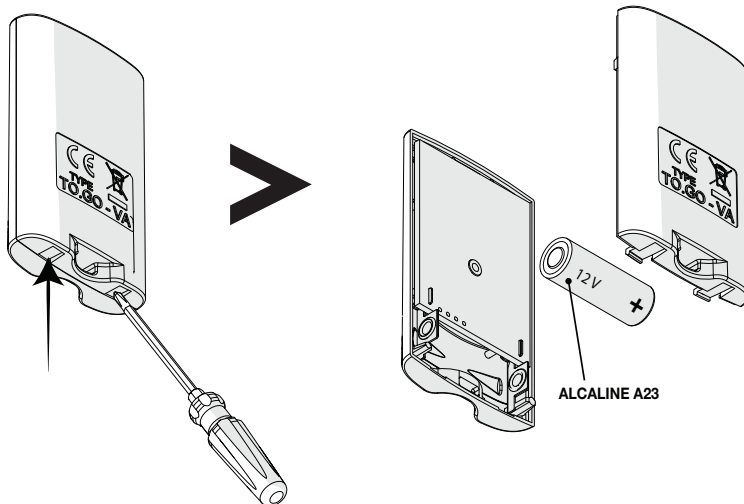

HAPPY

To replace the battery, open the battery lid using a screwdriver as shown in the picture.

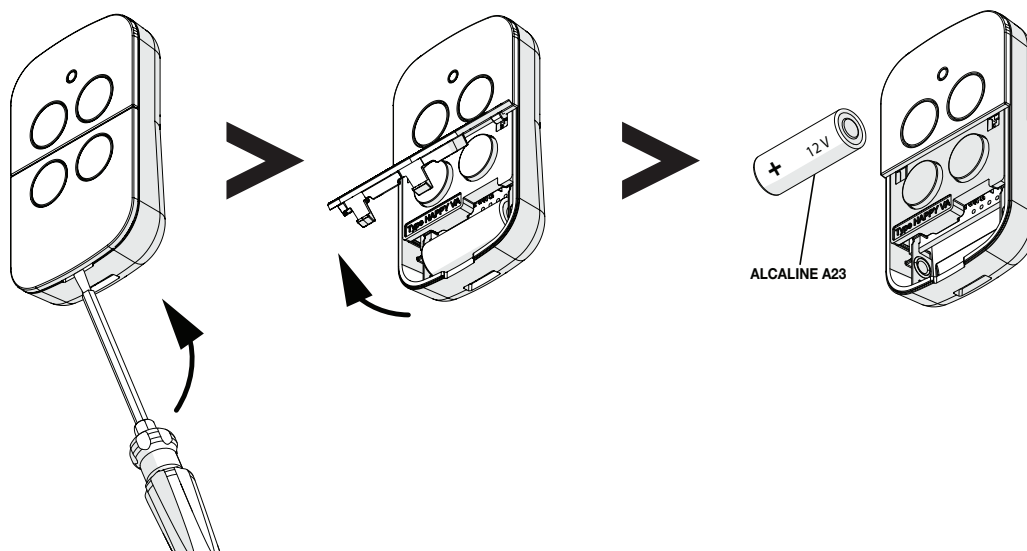

IRI.TX

Remove the screw, then rotate the metal part to open the transmitter, do not use the screwdriver or other equipment.

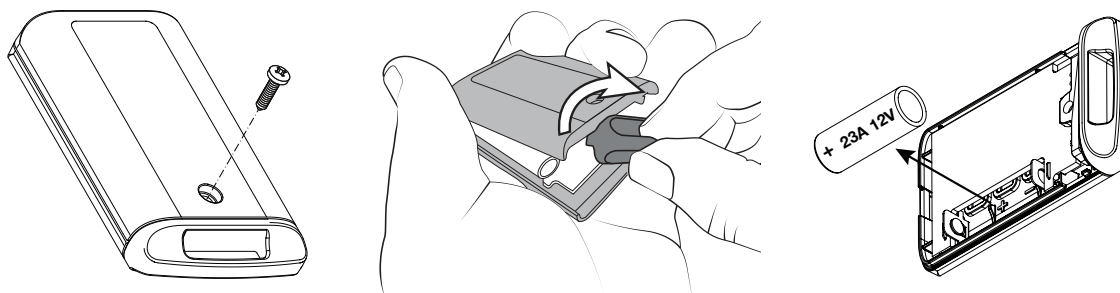

> INSTRUCTIONS FOR DISPOSAL



This symbol on the product or on its packaging indicates that this product must not be disposed of with your other household waste. Instead, it is your responsibility to dispose of your waste equipment by handing it over to an authorized collection point for the recycling of waste electrical and electronic equipment. In most Member States, consumers may also return waste equipment to the retailer on an old for new (1 for 1) basis. Large retailers (with sales area dedicated to selling electronic equipment over 400m²) should also allow consumers to return small WEEE (products having no external side bigger than 25cm) without a new product purchase obligation (1 for 0 basis).

The separate collection and recycling of your waste equipment at the time of disposal will help to conserve natural resources and ensure that it is recycled in a manner that protects human health and the environment. For more information about where you can drop off your waste equipment for recycling, please contact your local city office or your household waste disposal service.

BENINCA[®]
TECHNOLOGY TO OPEN

AUTOMATISMI BENINCÀ SpA - Via Capitello, 45 - 36066 Sandrigo (VI) ITALY - Tel. 0444 751030 r.a. - Fax 0444 759728

www.beninca.com - sales@beninca.it
